

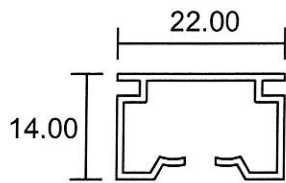

**Miscellaneous**



**21036**

0.201 Kg/m

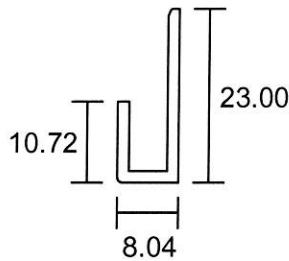

**21047**

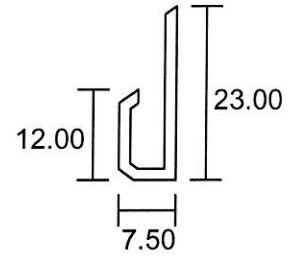

**504J**

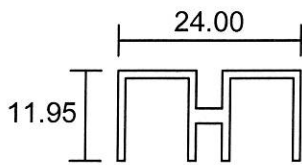

**5300**

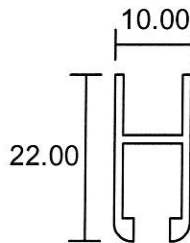

**5100**

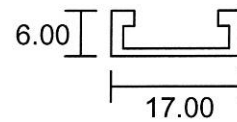

**5101**

0.084 Kg/m

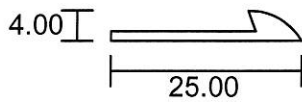

**6358**

0.104 Kg/m

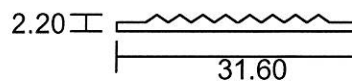

**6359**

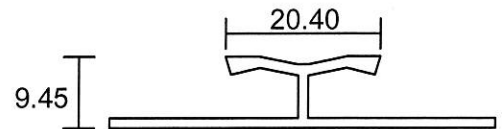

**TWIN BAR**

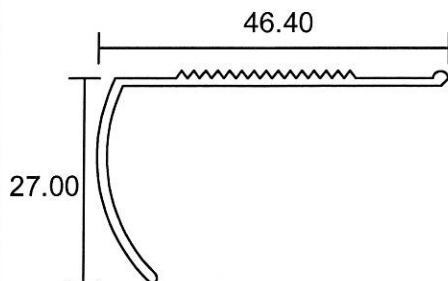

**1885N**

0.265 Kg/m

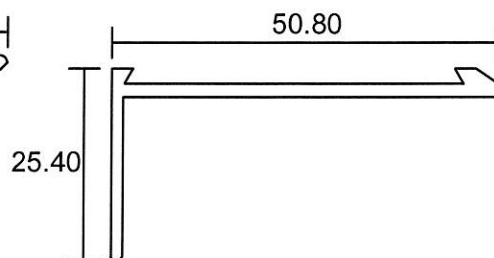

**1885A**

0.369 Kg/m

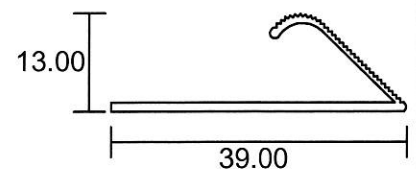

**5807**

0.137 Kg/m



**Miscellaneous**

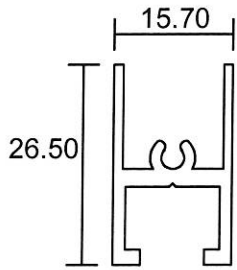

**1552**

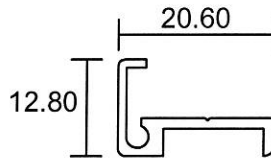

**1553**

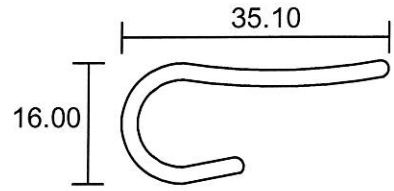

**721**

0.337 Kg/m

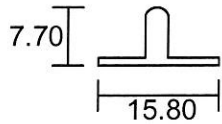

**5904**

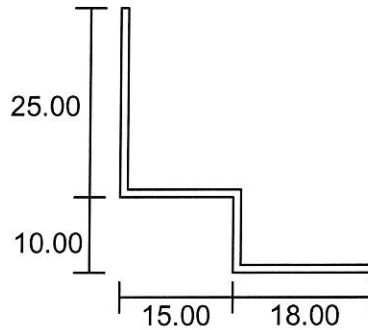

**W ANGLE**

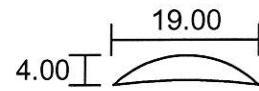

**5816**

0.099 Kg/m

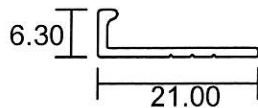

**6406**

0.088 Kg/m

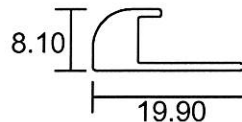

**6407**

0.163 Kg/m

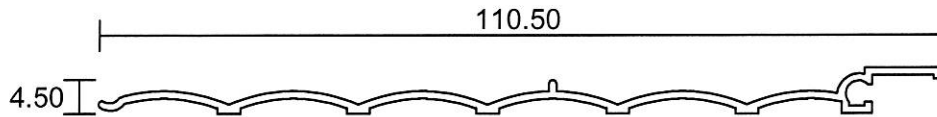

**1933**

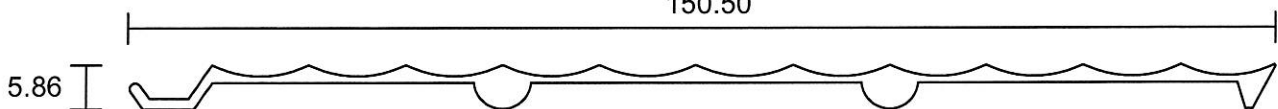

**6685**

0.675 Kg/m



**Eurogreen Building Products Pte Ltd**

56 BENDEMEER ROAD  
SINGAPORE 339936  
TEL : 84002232  
Website : www.eurogreen.com.sg  
Email : sales@eurogreen.com.sg

**Miscellaneous**

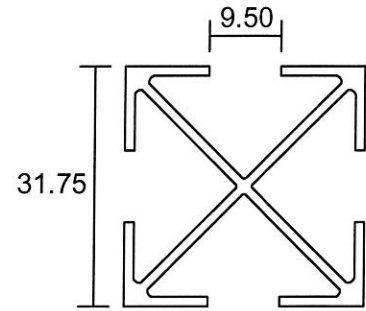
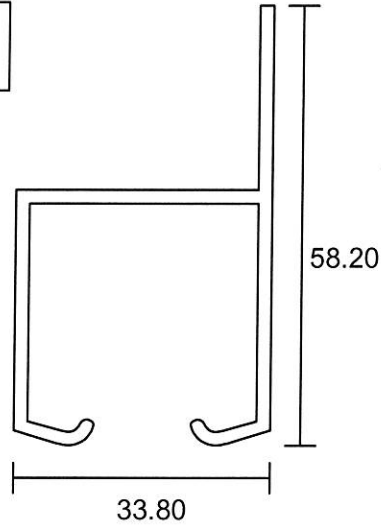
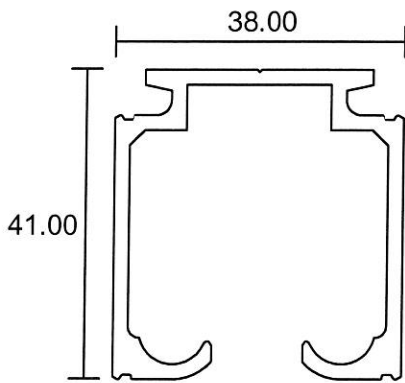

**15608**

0.862 Kg/m

**1532**

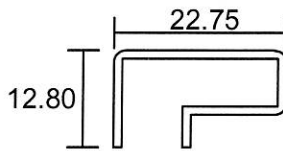

**TABLE LEG**

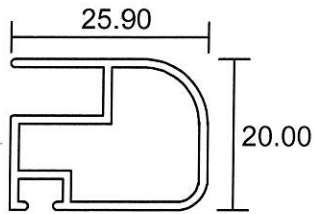
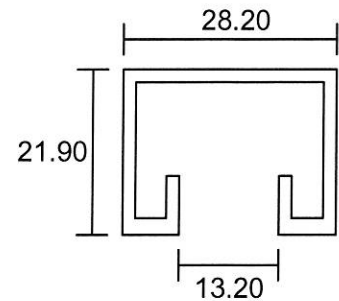

**1210**

0.301 Kg/m

**1211**

0.171 Kg/m

**HEAVY  
DUTY POLE**

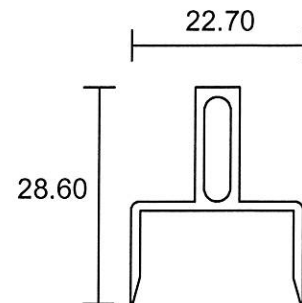
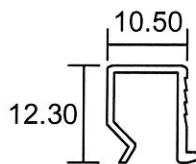
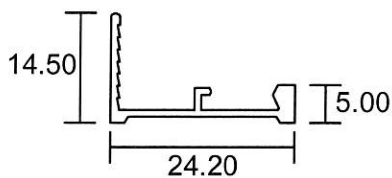

**SPF5**

0.136 Kg/m

**SPF5A**

0.100 Kg/m

**1795**

- Drawings are not drawn to scale

**MI-03**